

LFE SERIES Outdoor Lighting

LFE-50W-MCT-TR-P
COMPACT FLOOD LIGHT

MCT Multi Color Temperature (Selectable)

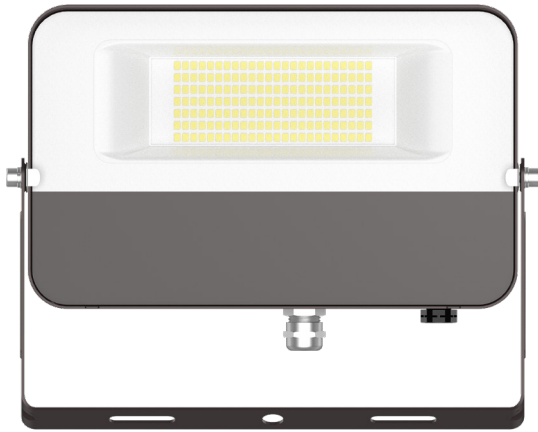

Ideal for general site lighting, alleys, loading docks, doorways, pathway, parking areas. Replace existing HID flood lights/wall packs. Great for use with motion sensors or other instant on/off controls. Solid state lighting technology for long life, low maintenance and high efficiency.

Customer Name: _____
Project Name: _____
Note: _____ | Type: _____

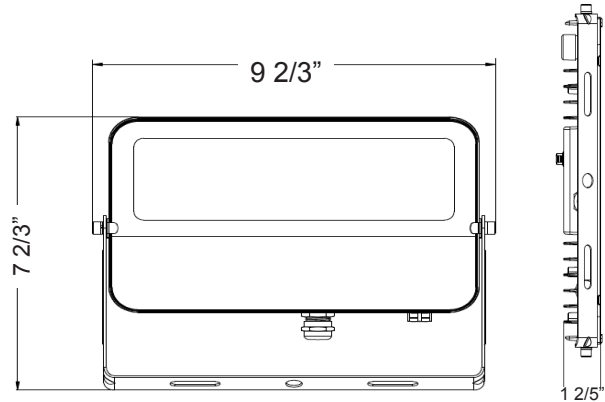

7 2/3"(H) x 9 2/3"(W) x 1 2/5"(D)

Features

- 270° Adjustable Yoke Mount
- MCT: Multi Color Temperature (Switch On The Back of Fixture With Silicon Cover)
- 7-Year Warranty
- 70,000 hours rated life
- Low Maintenance Needed and High-Efficiency

Technical Specifications

Electrical:

- Voltage: 120V AC 50/60Hz
- Wattage: 50W
- Power Factor: >0.9
- Efficacy: 105 LPW
- THD: <25%

Mechanical:

- Die-Cast Aluminum Housing With Powder Coat Finish (Dark Bronze Finish)
- Integrated DC Button Photocell Included
- Solid State Lighting Technology For Long Life, No Maintenance Needed and High-Efficiency
- High Conductive Aluminum LED Board
- IP Rating: IP65
- Operating Temperature: -40°F to 104°F
- Suitable for Wet Locations

Lighting:

- Cord type: 18" SJTW 18/3 AWG cable
- MCT: Multi Color Temperature (Switch On The Back of Fixture With Silicon Cover)
- Total lumens: 5250LM
- Color temperature: 3000K/ 4000K/ 5000K
- Color rendering index: CRI > 70
- Beam Angle: 120° x 90°

Applications:

- Ideal for general site lighting, alleys, loading docks, doorway, pathway and parking areas.
- Replace existing HID flood lights/ wall packs
- Great for use with motion sensors or other instant on/off controls

Other Models:

- 15W | 1600LM | LFE-15W-MCT-TR-P
- 30W | 3250LM | LFE-30W-MCT-TR-P



Photometrics: LFE-50W-MCT-TR-P

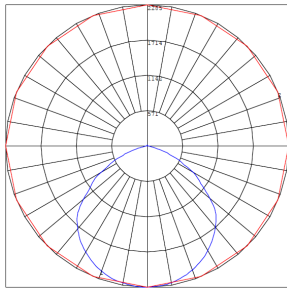
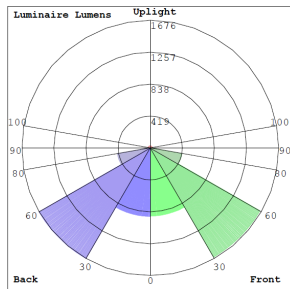

BUD Rating: B2-U2-G1

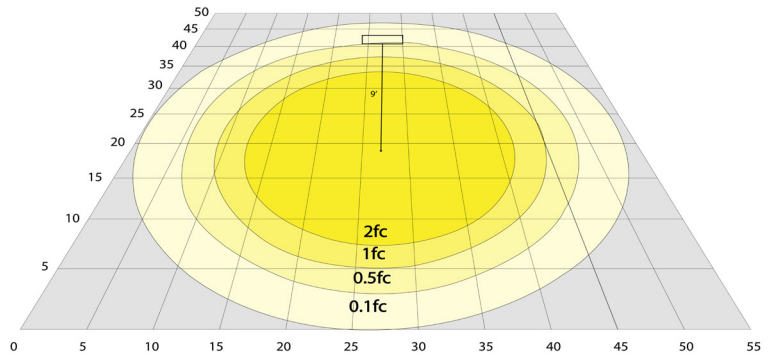

Area 50'x 55' Mounting Height: 9'

Other Views:



Side View

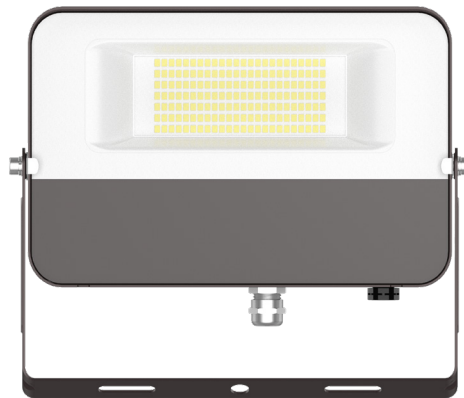

Front View

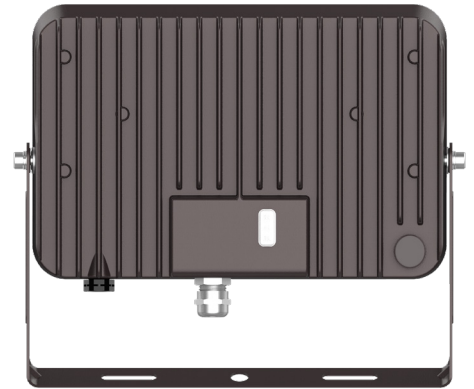

Back View

Performance Table: LFE-50W-MCT-TR-P

MODEL NO.	Wattage	Voltage	Lumens	Color Temp.	BUG Rating	LPW
LFE-50W-MCT-TR	50W	120V	5250LM	3000K 4000K 5000K	B2-U2-G1	105

Sample Ordering

Model Wattage Color Temp. Arm Photocell

LFE - 50W - MCT - TR - P

